

85  
SERIE TUBI  
TUBE SERIES

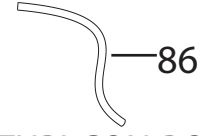

SERIE TUBI CON BOCCOLE  
TUBE SERIES WITH BUSHES

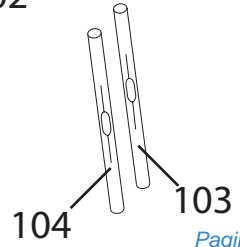
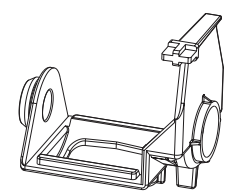
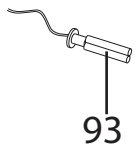
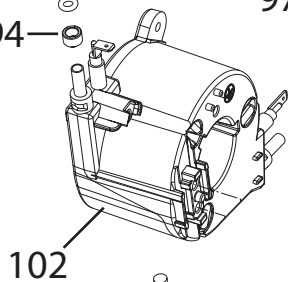
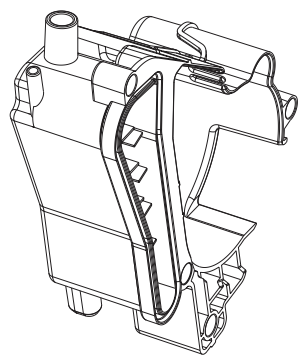
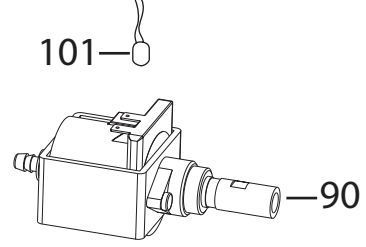
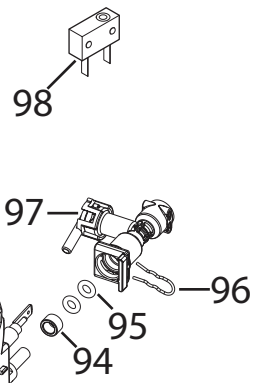
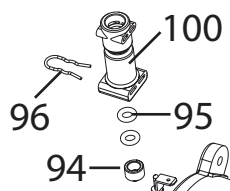
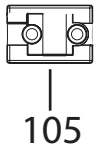
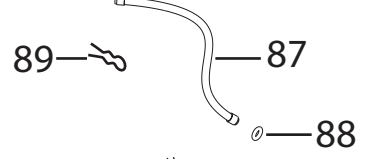

Posizione	Codice	Descrizione
	533135	O-RING
	5332169200	MISURINO
	5032111900	CAVO ALIMENTAZIONE
	5313256701	COPERCHIO GENERATORE NERO(PA) ECAM510
	5332224100	CINGHIA MOTORE MACININO
	5013251461	CABLAGGIO FLUSSIMETRO
	5313213411	PORTINA
	5513211891	PENNELLO-RASCHIETTO+SETOLE NERO(PP) ECAM
	6113210111	STAFFA TCO(ACC.C70) (GENERATORE) ECAM
	6113210121	STAFFA
	IT0198 SEE TECNICAL INFORMATION IT0198	RICAMBI AGGIUNTIVI SU CHASSIS . VEDI INFOTECNICA IT0198
	IT0198_ SEE TECNICAL INFORMATION IT0198	RICAMBI AGGIUNTIVI SU CHASSIS . VEDI INFOTECNICA IT0198
	5313224911	GUARNIZIONE
	5313213451	FERMACAVO
	5313219181	GUARNIZIONE A SOFFIETTO MACININO
	7313212631	CARRELLO
	5313213911	COPERCHIETTO
	SER0354	GRASSO LUBRIFICANTE VERKOFOOD WR2 TUBO 5GR
	IT1000	TERMOMETRO DIGITALE PORTATILE, -50° +150°
001	5313221031	COPERCHIO POLVERE
002	5513214851	COPERCHIO
003	7313222211	ASS. COPERCHIO
004	5913212611	MANOPOLA
005	5513222561	SCHIENALE
006	5513217011	FIANCO SX
007	5313219211	SERBATOIO
009	5313213441	SUPPORTO INTERRUTTORE
010	5513217001	FIANCO DX
011	5313251441	COVER
012	7313254561	TANK
013	5313215251	FRONTALINO

014	5313223071	CASSETTO
016	6013211171	POGGIATAZZE
017	5313218581	VASCHETTA
018	5313222641	GALLEGGIANTE
019	5132112500	INTERRUTTORE
021	5313213551	VASCHETTA
025	7313221141	ASS. CRUSCOTTO
026	5213216011	SCHEDA DISPLAY
031	7313212901	EROGATORE
033	5313217741	O-RING
035	7313218741	RUBINETTO
036	5513222441	MANOPOLA
037	5513214861	VETRINO
038	7313219311	CAPPUCCINATORE
039	5313220031	O-RING
040	5313217751	O-RING
041	5332169300	TUBO INFERIORE
042	5513270219	TUBETTO
047	5213219041	SENSORE REED
048	5213218521	SCHEDA POTENZA
049	532233	GOMMINO
050	5313213841	FERMO
054	7313251451	INFUSORE CAFFE
058	9812631250	VITE
059	6013213181	FILTRO (TAI-FENG)
060	5332139600	TAPPO
061	5332139500	VALVOLA
062	6132112200	MOLLA
063	5332149100	O-RING
065	5313227651	COPERCHIO
066	7313230501	MACININO COMPLETO
071	5313213591	TAPPO
073	7313214521	REGOLATORE
074	5313213431	GOMMINO
075	5513228021	KIT TRASMISSIONE ( ECM)
076	5213215001	SCHEDA MOTORE (ECM)
077	5132110500	MICROINTERRUTTORE
078	7313217261	ASS. MOTORE (ECM)

079	5213213971	SENSORE HALL
080	5313243071	CINGHIA
081	5313236711	TUBO 90°
082	5132104100	MICROINTERRUTTORE
084	5313217601	FILTRO
085	5513227961	MECCANOVALVOLA
086	5313217861	TUBO DI=3 DE=5,5 L=145
086	5313217871	TUBO DI=3 DE=6 L=200
086	5332199500	TUBO (SIL NAT)DI=4 DE=8 L=150
087	5513212871	TUBO PTFE DI2-DE4 L=97 2BOCCOLE
087	5513212881	TUBO PTFE DI2-DE4 L=270 2BOCCOLE
087	5513212891	TUBO PTFE DI2-DE4 L=230 2BOCCOLE
087	5513212901	TUBO PTFE DI2-DE4 L=290 2BOCCOLE
088	5313217701	O-RING D=3,85
089	6132101300	CLIP
090	5113211311	POMPA
091	5513211371	REGOLATORE
093	5213215651	SENSORE NTC
094	5332239300	DISTANZIALE 5XD5.2XD7.9 NATURAL
095	5313217701	O-RING D=3,85
096	6113210021	CLIP
097	7313219401	VALVOLA DI SICUREZZA
098	5113210211	MICROINTERRUTTORE
099	5213214671	FLUSSIMETRO
100	5332239200	CONNETTORE
101	5213211161	PROTETTORE
102	5513214291	GENERATORE
103	5013251391	CABLAGGIO TCO
104	5013251401	CABLAGGIO TCO
105	5513214661	CURSORE