

SERIE TUBI  
TUBE SERIES

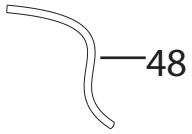

SERIE TUBI CON BOCCOLE  
TUBE SERIES WITH BUSHES

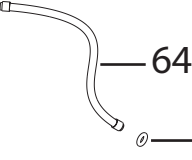

72

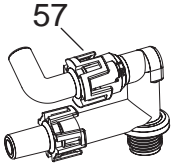
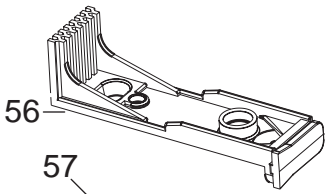
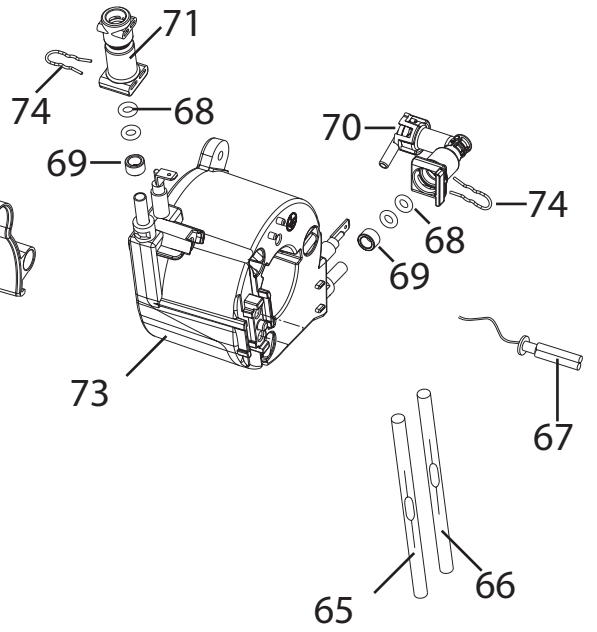

100

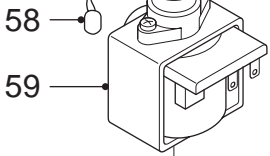

60

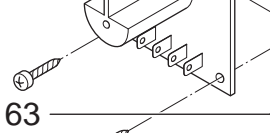
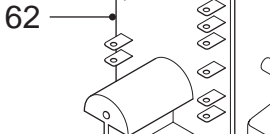
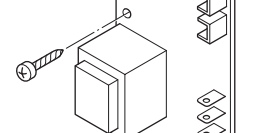
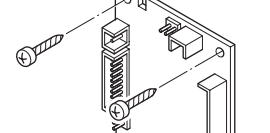
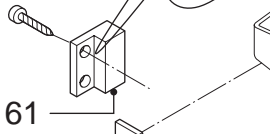

63

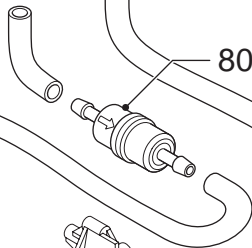

80

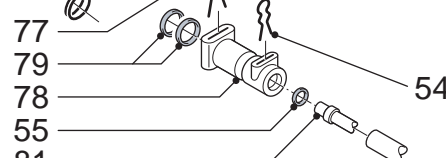

77  
79  
78  
55  
81

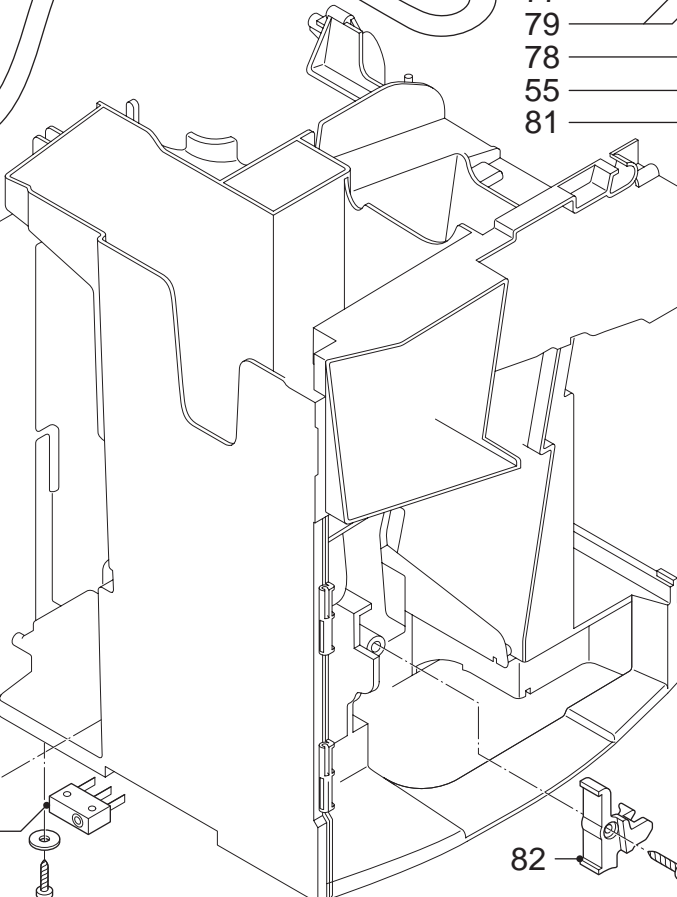

82

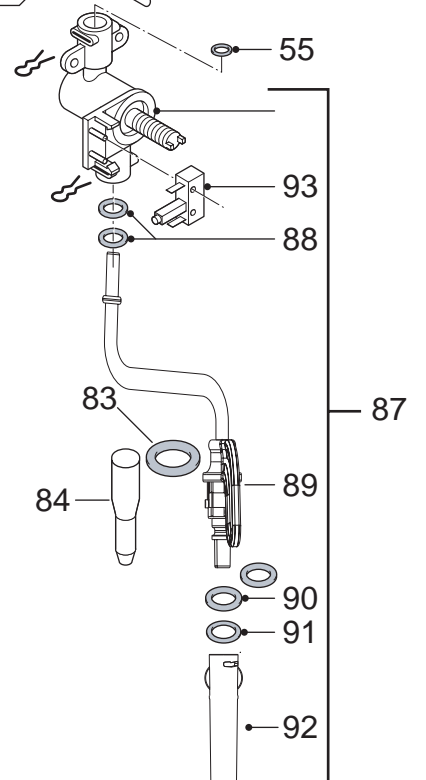

55  
87  
93  
88  
83  
84  
89  
90  
91  
92

Posizione	Codice	Descrizione
	5332108700	GUARNIZIONE
	5032514800	CABLAGGIO FLUSSIMETRO L470
	5313210401	COPERCHIO
	5332224100	CINGHIA MOTORE MACININO
	5332164700	PATTINO TELAIO
	5013252911	CAB CONTATORE-VOLUMETRICO L630(PVC) MCSA
	5313215891	GOMMINO ANTIMACCH GREY(EPDM70Z 70SH)MCSA
	5313218941	SUPPORTO GENERATORE NERO (PA) ESAM04
	6113210111	STAFFA TCO(ACC.C70) (GENERATORE) ECAM
	6113210121	STAFFA
	6913210021	SUPPORTO EL.VALVOLA 2VIE(S.VAP)SGSS MCSA
	6913210031	SUPPORTO EL.VALVOLA 3VIE SGSS MCSA
	6913210011	STAFFA
	5032110800	3X1 H05VVF10A L1900 NERO (SHK90°)MCSA
	6932103900	GRIGLIA
	5332177900	COPERCHIO CAMERA ESPANSIONE(PP)EAM3IFD
	5332238300	TUBO 90°
	5332270300	COPERTURA
	5332163200	MANIGLIA BICCHIERE CROMATA
	5313219181	GUARNIZIONE A SOFFIETTO MACININO
	5313239751	PARATIA
	SER0354	GRASSO LUBRIFICANTE VERKOFOOD WR2 TUBO 5GR
	IT1000	TERMOMETRO DIGITALE PORTATILE, -50° +150°
001	5332143500	COPERCHIO
002	5332143400	COPERCHIETTO
004	5332262600	CHIUSURA
005	5332143900	FIANCO SX
006	5913210471	MANOPOLA
007	5532146600	SERBATOIO
008	5313218991	SCHIENALE
009	5332143800	FIANCO DX
010	5213212291	SCHEDA
011	VI000	VEDI INFOTECNICA
012	7313220641	ASSIEME PORTA
013	5332142600	GANCIO

014	5332145600	COPERCHIETTO
015	7313228241	SERBATOIO ACQUA
016	5332163400	PROFILO
017	5332164000	POGGIATAZZE
018	5332163900	VASCHETTA
019	5332225000	FONDO
020	5332266300	GALLEGGIANTE
023	5232110000	SCHEDA COMANDI 11 PIN
023	5213213011	SCHEDA COMANDI 8 PIN
027	7313223241	ASS. CRUSCOTTO
029	5513222511	MANOPOLA
030	6013213181	FILTRO (TAI-FENG)
031	5332149100	O-RING
032	7313251441	KIT INFUSORE
034	5513227971	MACININO COMPLETO
035	5332142200	SUPPORTO
036	6132104700	MOLLA
037	5132105700	MICROINTERRUTTORE
038	7332166600	SLITTA
039	5332142400	BUSSOLA
040	5332142300	BUSSOLA
042	5313217751	O-RING
043	5332213000	PERNO
044	5332148400	VALVOLA
045	6132106900	MOLLA
046	5332144900	GUARNIZIONE
047	5332139200	FILTRO
048	5332110600	TUBO (SIL NAT)DI=4 L=220
048	5332174600	TUBO (SIL NAT)DI=5 L=270
048	5332178100	TUBO (SIL NAT)DI=4 L=270
048	5332150700	TUBO (SIL NAT) DI=4 L=55
049	5113210421	MICROINTERRUTTORE
050	5132110500	MICROINTERRUTTORE
051	5213213971	SENSORE HALL
052	5313243071	CINGHIA
053	7313249601	KIT TRASMISSIONE (CHIAPHUA)
054	6132101300	CLIP
055	5313217701	O-RING D=3,85

056	5313216501	SUPPORTO
057	7313219431	VALVOLA
058	5213211161	PROTETTORE
059	5113211281	POMPA
060	534848	SUPPORTO
061	5232104600	SENSORE REED
062	5213213691	SCHEDA POTENZA
063	5132105400	MICROINTERRUTTORE
064	5513213801	TUBO PTFE DI2-DE4 L=180 2BOCCOLE
065	5013251401	CABLAGGIO TCO
066	5013251931	CABLAGGIO TCO
067	5217100200	SENSORE NTC
068	5313217701	O-RING D=3,85
069	5332239300	DISTANZIALE 5XD5.2XD7.9 NATURAL
070	5313218931	RACCORDO
071	5332239200	CONNETTORE
072	5313217701	O-RING D=3,85
073	5513214291	GENERATORE
074	6113210021	CLIP
075	7313217261	ASS. MOTORE (ECM)
077	6113210021	CLIP
078	5332239200	CONNETTORE
079	5313217701	O-RING D=3,85
080	5513220521	FILTRO
082	5332142600	GANCIO
083	5313219281	O-RING
084	5332113800	TUBO INFERIORE
085	5513227991	MECCANOVALVOLA
087	7313216621	RUBINETTO
088	5332144800	O-RING D=6
089	5513213371	TUBO INFERIORE
090	5313219271	O-RING
091	5313217751	O-RING
092	5332229600	COPERTURA
093	5113210421	MICROINTERRUTTORE
094	5332139800	LEVA
095	6132103500	MOLLA
096	9812631250	VITE

097	5332139600	TAPPO
098	5332139500	VALVOLA
099	6132112200	MOLLA
100	9824800014	FASCETTA