

85
SERIE TUBI
TUBE SERIES

SERIE TUBI CON BOCCOLE
TUBE SERIES CON BOCCOLE

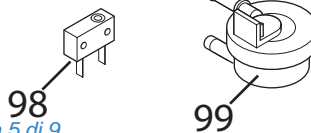
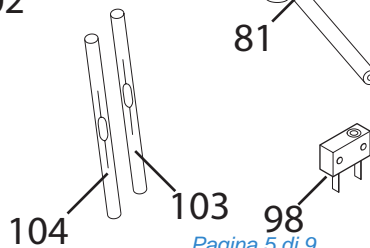
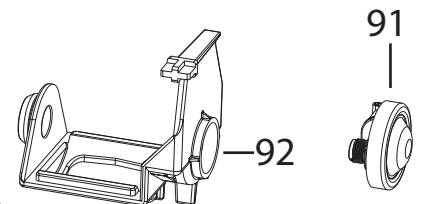
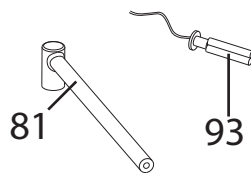
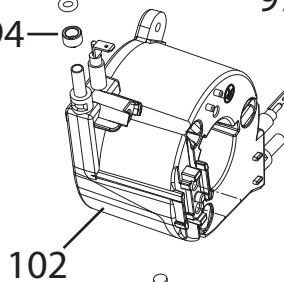
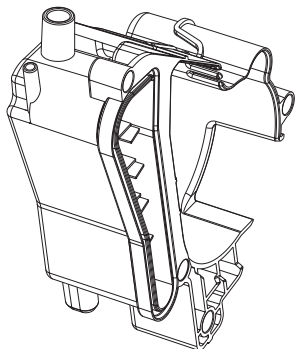
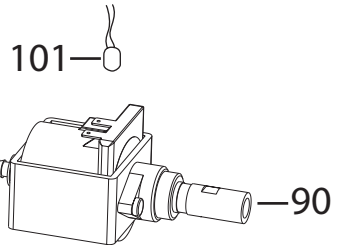
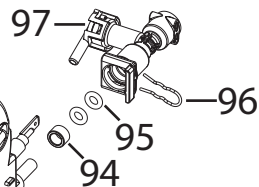
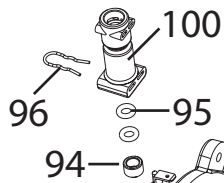
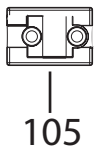
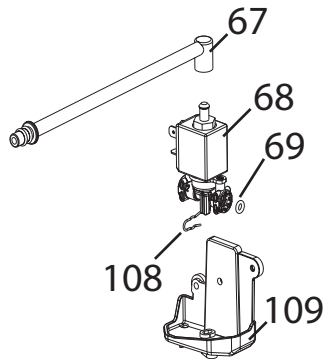

Posizione	Codice	Descrizione
	5332169200	MISURINO
	5032111900	CAVO ALIMENTAZIONE
	5313256701	COPERCHIO GENERATORE NERO(PA) ECAM510
	5332224100	CINGHIA MOTORE MACININO
	5013251461	CABLAGGIO FLUSSIMETRO
	5313213411	PORTINA
	5313218941	SUPPORTO GENERATORE NERO (PA) ESAM04
	5513211891	PENNELLO-RASCHIETTO+SETOLE NERO(PP) ECAM
	6113210111	STAFFA TCO(ACC.C70) (GENERATORE) ECAM
	6113210121	STAFFA
	IT0198 SEE TECNICAL INFORMATION IT0198	RICAMBI AGGIUNTIVI SU CHASSIS . VEDI INFOTECNICA IT0198
	IT0198_ SEE TECNICAL INFORMATION IT0198	RICAMBI AGGIUNTIVI SU CHASSIS . VEDI INFOTECNICA IT0198
	5313213451	FERMACAVO
	5313219181	GUARNIZIONE A SOFFIETTO MACININO
	SER0354	GRASSO LUBRIFICANTE VERKOFOOD WR2 TUBO 5GR
	IT1000	TERMOMETRO DIGITALE PORTATILE, -50° +150°
001	5313213711	COPERCHIO POLVERE
002	5513214151	COPERCHIO
003	7313223311	ASS. COPERCHIO
004	5313213421	INDICATORE
005	5313220201	SCHIENALE
006	5313220191	FIANCO SX
007	5313213461	SERBATOIO
008	5313213721	CERNIERA
009	5313213441	SUPPORTO INTERRUTTORE
010	5313220181	FIANCO DX
011	5313251441	COVER
012	7313254561	TANK
013	5313223631	FRONTALINO
014	5313213561	CASSETTO
015	5313223611	FRONTALINO

016	IT0252	VEDI INFOTECNICA
017	5313224851	VASCHETTA
018	5313222641	GALLEGGIANTE
019	5132112500	INTERRUTTORE
020	5313220101	FRONTALINO
021	5313213551	VASCHETTA
025	7313222261	ASS. CRUSCOTTO
026	5513213521	SCHEDA
027	5313213911	COPERCHIETTO
028	5313213901	SERBATOIO
029	6132106200	MOLLA
030	5332227400	REGOLATORE
031	5313213881	COPERCHIO
032	5313215321	MANIGLIA
033	5313215311	CONVOGLIATORE
035	7313221801	COPERCHIO
036	5332131100	TUBO
037	5513213511	PIPETTA
038	5313231231	CARAFFA
039	6132101300	CLIP
040	5313220031	O-RING
041	5313221011	O-RING
042	9813421316	VITE
043	5313218821	SUPPORTO MICRO
045	6113210411	MOLLA
046	5313220141	SFERA
047	5213219041	SENSORE REED
048	5213213671	SCHEDA POTENZA
049	532233	GOMMINO
050	5313220131	GOMMINO
051	7313244781	INNESTO CARAFFA
054	7313251451	INFUSORE CAFFE
055	6113210131	MOLLA
056	5313213241	GOMMINO
057	5313213191	LEVA
059	6013213181	FILTRO (TAI-FENG)
060	5332139600	TAPPO
061	5332139500	VALVOLA

062	6132112200	MOLLA
064	5313213211	PISTONE
065	5313210401	COPERCHIO
066	7313227621	MACININO COMPLETO
067	5313227841	TUBO 90°
068-	5513225811	KIT ELETTRIVALVOLA 3V
068	5213214031	ELETTRIVALVOLA 3V PLASTICA
070	9812631250	VITE
071	5313213591	TAPPO
072	7313212631	CARRELLO
073	7313214521	REGOLATORE
074	5313213431	GOMMINO
075	5513228011	KIT TRASMISSIONE (ECM)
076	5213215001	SCHEDA MOTORE (ECM)
077	5132110500	MICROINTERRUTTORE
078	7313217261	ASS. MOTORE (ECM)
079	5213213971	SENSORE HALL
080	5313243071	CINGHIA
081	5313236711	TUBO 90°
082	5132104100	MICROINTERRUTTORE
083	5332149100	O-RING
084	5313217601	FILTRO
085	5513227961	MECCANOVALVOLA
086	5313217861	TUBO DI=3 DE=5,5 L=145
086	5313217871	TUBO DI=3 DE=6 L=200
086	5332199500	TUBO (SIL NAT)DI=4 DE=8 L=150
087	5513212871	TUBO PTFE DI2-DE4 L=97 2BOCCOLE
087	5513212881	TUBO PTFE DI2-DE4 L=270 2BOCCOLE
087	5513212901	TUBO PTFE DI2-DE4 L=290 2BOCCOLE
087	5513213901	TUBO PTFE DI2-DE4 L=320 2BOCCOLE
087	5513226831	TUBO PTFE DI2-DE4 L=500 2BOCCOLE
088	5313217701	O-RING D=3,85
090	5113211311	POMPA
091	5513211371	REGOLATORE
092	5313230671	SUPPORTO
093	5213215651	SENSORE NTC
094	5332239300	DISTANZIALE 5XD5.2XD7.9 NATURAL
095	5313217701	O-RING D=3,85

096	6113210021	CLIP
097	7313219401	VALVOLA DI SICUREZZA
098	5113210211	MICROINTERRUTTORE
099	5213214671	FLUSSIMETRO
100	5332239200	CONNETTORE
101	5213211161	PROTETTORE
102	5513214291	GENERATORE
103	5013251391	CABLAGGIO TCO
104	5013251401	CABLAGGIO TCO
105	5513214661	CURSORE
108	6113210021	CLIP
109	5313218631	SUPPORTO
110	9930000855	GENERATORE